

# GT

## CONNECTOR

*High Current Connectors*

*Heat- Resistant Connectors*

*Vacuum Connectors*

*Connectors for Special Purpose*

## Contents

Intoroduction .....	2
Features and Type of Contact Band .....	4
Standard Connectors .....	8
Custom-Made Connectors	
Summary and Features .....	10
High Current Connectors .....	11
Heat Resistant Connectors .....	14
Feedthrough and Vacuum Connectors .....	16
Fork Socket .....	20
Draw out Connectors .....	22
Butt Contact .....	24
Connectors for Inspection process .....	28
Connectors for Nut and Screw .....	27
Our other products .....	30

### **GLOBETECH Inc.**

We are a company that designs and manufactures custom-made electrical connectors not handled by existing products. Using our core technology, electrical contacts for stabilizing energization, we manufacture high current connectors, heat-resistant connectors, vacuum connectors, and special connectors. Orders are accepted from a single unit. The connectors are basically manufactured by cutting work. To meet special specifications, we have no internal manufacturing equipment. Instead, we request cutting work and surface treatment from reliable external factories specializing in the work. Assembly is performed under internal control for shipment.

Please feel free to consult us if you have any issues about industrial electrical connectors.

### **Introduction**

What are connectors used for electrical connection?

The connector is an electrical component used to connect and disconnect components in electrical circuits. While there are other ways to connect electrical circuits, like fasteners (bolts and nuts) and soldering, if you want to connect and disconnect circuits quickly at short intervals, connectors are the most efficient.

### **Globetech's Connectors**

To reduce the resistance of electrical conductors and connections and to enhance reliability, it is necessary to press the conductors together with appropriate contact pressure.

While, in general, a slit is inserted into the conductor to create range of motion or a spring with a simple structure is used to generate contact pressure for easy insertion and extraction, Globetech's connector employs a spring material for the electrical contact.

We manufacture connectors for many applications by choosing the electrical contact from a variety of items. We offer even a single connector specially made to meet a customer's specifications.

## Features of Connectors Using Electrical Contact

- Reduces loss of electricity when high current is applied thanks to low-contact resistance
- Longer life for repeated insertion and extraction
- Capable of reducing insertion and extraction force and suitable for multi-polarity
- The multipoint contact structure moves independently for tracking when an irregular
- Applicable in high temperature environments
- Resistant to oxide film because of the self-cleaning function
- Compact size in the direction of diameter and axis
- Compensates for mating misalignment
- Stabilizes signal voltage

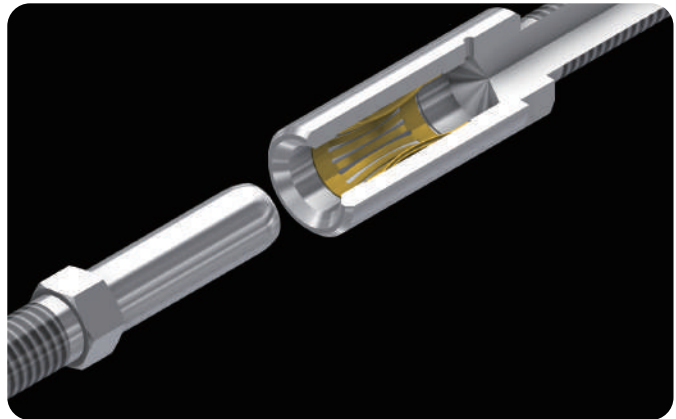

## Contact Band and Coil Spring Contact

Two types of electrical contacts—the Contact Band and Coil Spring Contact—are used in Globetech connectors. The contact band is manufactured by pressing a sheet of high-performance spring material. The coil spring contact is manufactured by winding wire materials to create a spring consisting of canted coils and then welding them to form a circular shape.

We choose the optimum type for each contact depending on the specifications, application, and cost, and then we design a connector best suited to the needs of the customer.



Contact Band



Coil Spring Contact

## Features and Type of Contact Band

- Silver plating or gold plating on beryllium copper alloy
- Louver structure suited for energization of high current
- Low cost and mass production using a progressive die
- Made-in-Japan products ensure high quality and short delivery time
- Contacts in different diameters and contact band types are available in the inventory
- Superior capability to remove oxide film thanks to the wiping function of the heat cycle

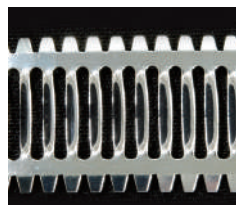
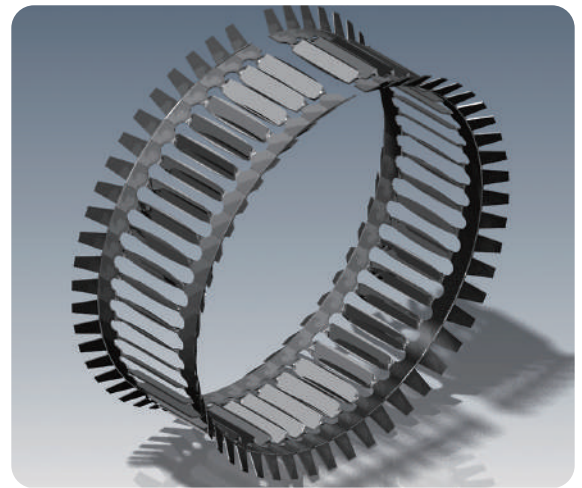

Installation width	Louver pitch	Current / louver
18mm / .7in.	2.54mm / .1in.	25A

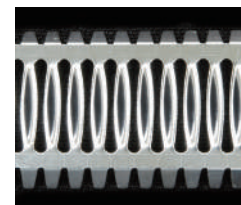

Installation width	Louver pitch	Current / louver
18mm / .7in.	2.54mm / .1in.	25A

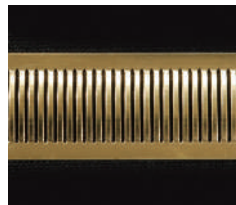

Installation width	Louver pitch	Current / louver
12.5mm / .49in.	1mm / .04in.	7A



Installation width	Louver pitch	Current / louver
8.5mm / .33in.	0.8mm / .03in.	5A



Installation width	Louver pitch	Current / louver
5.5mm / .22in.	0.7mm / .03in.	3A



Installation width	Louver pitch	Current / louver
10mm / .39in.	3.3mm / .13in.	45A

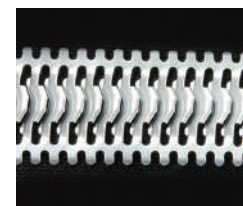

Installation width	Louver pitch	Current / louver
13.1mm / .51in.	2mm / .08in.	25A



## Features and Type of Contact Band

- Silver plating or gold plating on beryllium copper alloy
- Louver structure suited for energization of high current
- Low cost and mass production using a progressive die
- Made-in-Japan products ensure high quality and short delivery time
- Contacts in different diameters and contact band types are available in the inventory
- Superior capability to remove oxide film thanks to the wiping function of the heat cycle

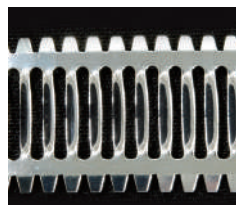
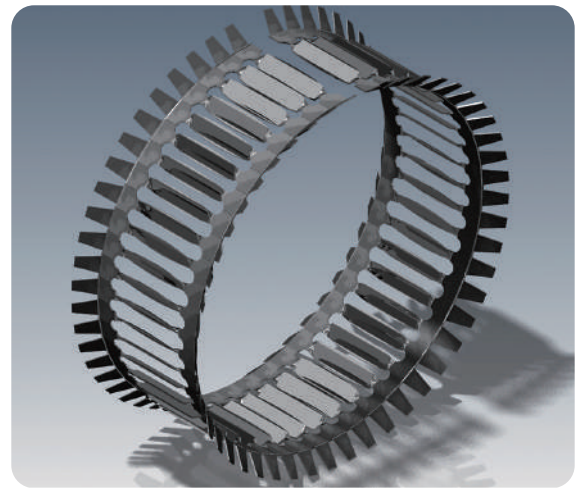

Installation width	Louver pitch	Current / louver
18mm / .7in.	2.54mm / .1in.	25A

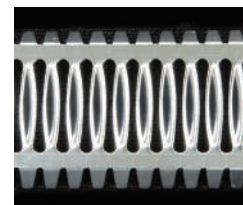

Installation width	Louver pitch	Current / louver
18mm / .7in.	2.54mm / .1in.	25A

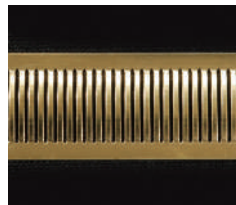

Installation width	Louver pitch	Current / louver
12.5mm / .49in.	1mm / .04in.	7A



Installation width	Louver pitch	Current / louver
8.5mm / .33in.	0.8mm / .03in.	5A



Installation width	Louver pitch	Current / louver
5.5mm / .22in.	0.7mm / .03in.	3A



Installation width	Louver pitch	Current / louver
10mm / .39in.	3.3mm / .13in.	45A

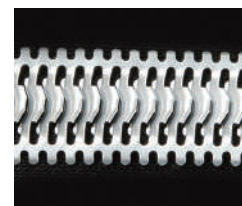

Installation width	Louver pitch	Current / louver
13.1mm / .51in.	2mm / .08in.	25A

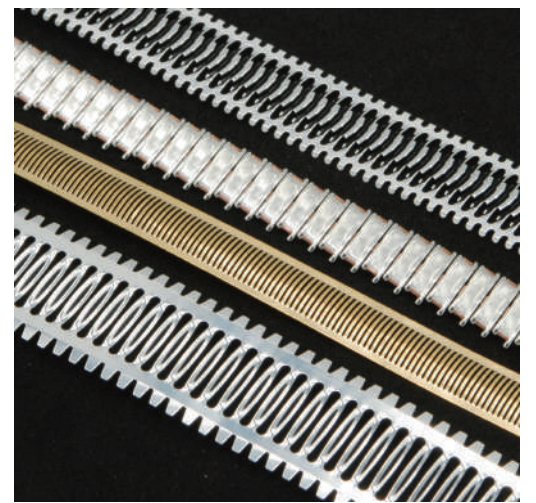
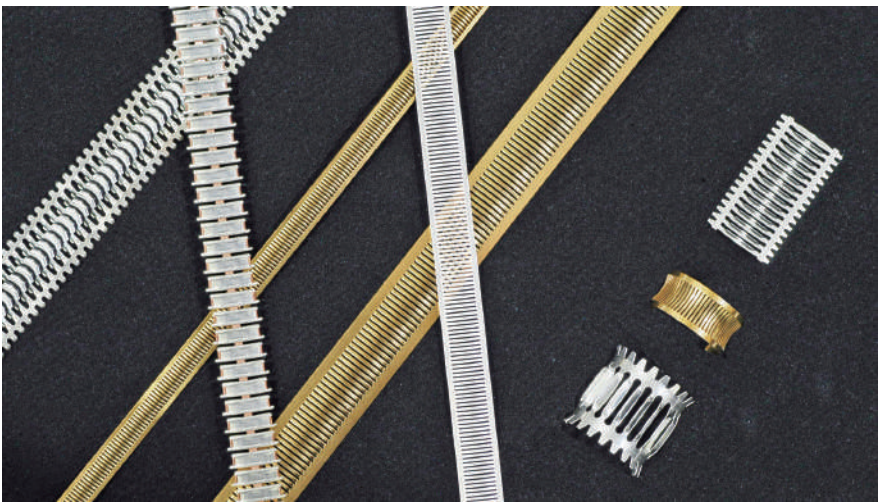



## Installation Style of Contact Elements

### *Install to Socket*

The standard shape of the electrical contact is installed in the inner diameter of the socket. The mating pair connected to the socket has the shape of a round bar.



### *Install to Plug*

The shape with the electrical contact is installed in the outer diameter of the plug. The plug is connected to the inner diameter of the round hole.



### *Butt Contact*

The shape with the electrical contact is installed using grooves on an energization block. The mating pair connected to the block is a flat surface that can be energized. This type is suitable for applications where the contacts are repeatedly pressed such as on an automation equipment.

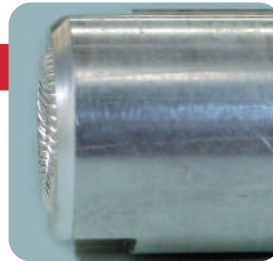

### *Fork Socket*

This socket is used for applications where a flat board subject to energization is laterally pinched to make the connection. The electrical contact is linearly installed.

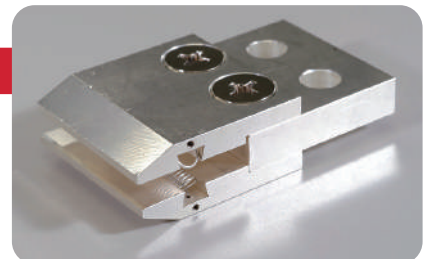

### *Flat Contact*

The electrical contact is mounted on an energized surface secured by screws. Effective energization is enabled by the electrical contact even when the contact area or contact pressure is reduced because of loosened screws or warpage of the flat surface.



### *Rotating parts*

The electrical contacts can be used for electrical connections on rotating parts if they rotate at a relatively slow speed.



# Application Case of Our Connectors

## **Power**

Switch Gear / Circuit Breaker / Disconnecting Switch / Transformer / Current Transformer / GIS / C-GIS  
Uninterruptible Method Equipment / Cable Head / Underground Distribution Equipment / Fuel Cell  
Solar Battery / Wind-Power Generation/Inverter

## **Semiconductor Manufacturing Equipment**

Single Crystal Pulling Apparatus / Exposure Device / Sputtering Equipment / CVD Equipment  
Vacuum Coating Equipment / Etching Equipment / Ion Implantation Equipment / Prober  
Electrostatic Chuck / Heater / Transfer Robot

## **Manufacturing Equipment and Inspection of Automotive**

Inverter / IGBT / Battery / Capacitor / Motor / ECU / Electric Power Steering / Electric compressor  
Magnetizing Equipment / Robot Welding Machine / Tool Changer / Quick Charger / AGV

## **Industrial Machinery**

Laser Beam Machine / Electrical Discharge Machine / Electromagnetic Mixer / Welding Machine  
Underwater Pump / Plating Equipment / Electroforming Equipment / Ultraviolet Curing Equipment  
Injection Molding Machine

## **Railroad**

Jumper Power Connector / Jumper for Communication Connector  
Connector for Vehicle Underfloor Equipment / Connector for Vehicle Equipment

## **Medical and Study**

MRI / CT Scanner / PET / Heavy Ion Radiotherapy Device / Shadowless Light / Electronic Microscope  
Anechoic Chamber / Ultrasonic Probe

## **Electrical Testing Equipment**

Inspection for Smart Meter / CT / LED Lighting Device / Electron Tube

## **Other**

Ground Power for Vessel / Ground Power for Aircraft / Studio Lighting / Mountain Construction Equipment  
Accelerator / Nuclear Fusion Experimental Device



## Standard Connectors

For customers who wish to use our products immediately, Globetech offers standard connectors like the non-insulated plug and socket and the plug with insulation case and receptacle. The simple design allows for use in a variety of applications. We can also create products from customized designs by changing the materials, plating, dimensions, or other features of the standard items. We hope this helps you consider the design for your product.



### Sockets with thread termination

- Material of Connector Body : C3604 + Ag plating
- Material of Contact Band : Beryllium Copper + Au plating from MS2 to MS6.  
Beryllium Copper + Ag plating from MS8 to MS40.
- Maximum Temperature : +145°C (293°F)

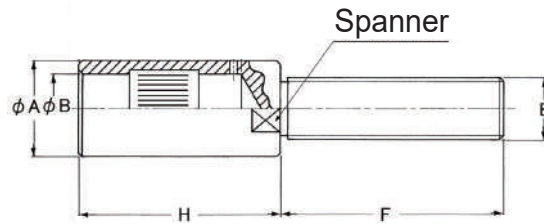

\* From MS2 to MS10 is incomplete thread.

Model	φ B dia. mm / inches	Rated current (A)	φ A dia. mm / inches	E mm	F mm / inches	H mm / inches	For Spanner mm / inches	Withdrawal Force (Kg / N)	Insertion Force (Kg / N)	Contact resistance (μΩ)	Weight (g / OZ)
MS2	2 / .08	25	5.5 / .22	M3	16 / .63	20 / .79	4 / .16	0.6 / 5.9	0.8 / 7.9	300	4 / 0.14
MS3	3 / .12	35	6 / .24	M4	20 / .79	20 / .79	5 / .20	0.8 / 7.9	1 / 9.8	200	5 / 0.18
MS4	4 / .16	50	7 / .28	M5	25 / .98	25 / .98	6 / .24	1.5 / 14.7	2.2 / 21.6	180	9 / 0.32
MS5	5 / .20	70	8.5 / .33	M5	25 / .98	25 / .98	7 / .28	1.6 / 15.7	2.2 / 21.6	150	11 / 0.39
MS6	6 / .24	90	10 / .39	M6	28 / 1.10	25 / .98	8 / .31	2 / 19.6	2.5 / 24.5	100	15 / 0.53
MS8	8 / .31	125	14 / .55	M8	36 / 1.42	42 / 1.65	11 / .43	2 / 19.6	2.5 / 24.5	60	47 / 1.66
MS10	10 / .39	180	16 / .63	M10	42 / 1.65	42 / 1.65	13 / .51	3 / 29.4	3.5 / 34.3	50	67 / 2.36
MS12	12 / .47	230	18 / .71	M12	48 / 1.89	42 / 1.65	13 / .51	3 / 29.4	3.6 / 35.3	40	88 / 3.1
MS14	14 / .55	280	20 / .79	M14	50 / 1.97	48 / 1.89	17 / .67	4.6 / 45.1	5.1 / 50	35	123 / 4.34
MS16	16 / .63	340	22 / .87	M16	58 / 2.28	48 / 1.89	19 / .75	6.6 / 64.7	7.1 / 69.6	25	163 / 5.75
MS18	18 / .71	400	25 / .98	M16	58 / 2.28	52 / 2.05	22 / .87	7.6 / 74.5	10.2 / 100	20	196 / 6.91
MS20	20 / .79	460	28 / 1.10	M18	70 / 2.76	52 / 2.05	24 / .94	8.1 / 79.4	12.2 / 119.6	15	270 / 9.52
MS25	25 / .98	620	38 / 1.50	M20	74 / 2.91	75 / 2.95	32 / 1.26	8.1 / 79.4	12.2 / 119.6	10	600 / 21.16
MS30	30 / 1.18	800	42 / 1.65	M24x2	82 / 3.23	75 / 2.95	36 / 1.42	10.2 / 100	12.2 / 119.6	9	740 / 26.10
MS35	35 / 1.38	1000	48 / 1.89	M30x2	90 / 3.54	75 / 2.95	41 / 1.61	12.2 / 119.6	15.3 / 150	8	1080 / 38.10
MS40	40 / 1.57	1200	52 / 2.05	M36x3	105 / 4.13	75 / 2.95	46 / 1.81	12.2 / 119.6	15.3 / 150	7	1430 / 50.44

Install Example

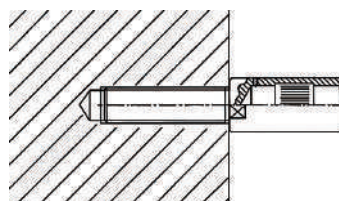

Contact Block

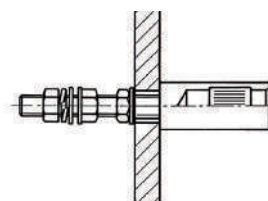

Insulated plate

## Plugs with thread termination

- Material of Connector Body : C3604 + Ag plating

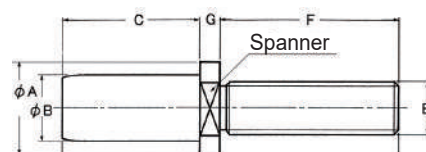

Model	$\phi B$ dia. mm / inches	Rated current (A)	$\phi A$ dia. mm / inches	Width across flat mm / inches	C mm / inches	E mm	F mm / inches	G mm / inches	Weight (g / OZ)
MP2N	2 / .08	25	4.7 / .19	4 / .16 (hex)	16.5 / .65	M3	16 / .63	3 / .12	2 / 0.07
MP3N	3 / .12	35	5.8 / .23	5 / .20 (hex)	16.5 / .65	M4	20 / .79	3.5 / .14	3 / 0.11
MP4N	4 / .16	50	7 / .28	6 / .24 (hex)	19.5 / .77	M5	25 / .98	4 / .16	6 / 0.21
MP5N	5 / .20	70	8.1 / .32	7 / .28 (hex)	19.5 / .77	M5	25 / .98	4 / .16	8 / 0.28
MP6N	6 / .24	90	9.3 / .37	8 / .31 (hex)	19.5 / .77	M6	28 / 1.10	4 / .16	12 / 0.42
MP8N	8 / .31	125	12.7 / .50	11 / .43 (hex)	34 / 1.34	M8	36 / 1.42	5 / .20	31 / 1.09
MP10N	10 / .39	180	15 / .59	13 / .51 (hex)	34 / 1.34	M10	42 / 1.65	5 / .20	51 / 1.80
MP12N	12 / .47	230	18 / .71	13 / .51 (D-Cut)	34 / 1.34	M12	48 / 1.89	5 / .20	79 / 2.79
MP14N	14 / .55	280	20 / .79	17 / .67 (D-Cut)	38 / 1.50	M14	50 / 1.97	7 / .28	121 / 4.27
MP16N	16 / .63	340	22 / .87	19 / .75 (D-Cut)	38 / 1.50	M16	58 / 2.28	7 / .28	170 / 6.00
MP18N	18 / .71	400	25 / .98	22 / .87 (D-Cut)	42 / 1.65	M16	58 / 2.28	7 / .28	203 / 7.16
MP20N	20 / .79	460	28 / 1.10	24 / .94 (D-Cut)	42 / 1.65	M18	70 / 2.76	7 / .28	271 / 9.56
MP25N	25 / .98	620	38 / 1.50	32 / 1.26 (D-Cut)	62 / 2.44	M20	74 / 2.91	9 / .35	506 / 17.85
MP30N	30 / 1.18	800	42 / 1.65	36 / 1.42 (D-Cut)	62 / 2.44	M24x2	82 / 3.23	9 / .35	745 / 26.28
MP35N	35 / 1.38	1000	48 / 1.89	41 / 1.61 (D-Cut)	62 / 2.44	M30x2	90 / 3.54	10 / .39	1149 / 40.53
MP40N	40 / 1.57	1200	52 / 2.05	46 / 1.81 (D-Cut)	62 / 2.44	M36x3	105 / 4.13	11 / .43	1656 / 58.41

## Sockets with external thread termination

- Material of Connector Body : C3604 + Ag plating
- Material of Contact Band : Beryllium Copper + Au plating from MS2N to MS6N.  
Beryllium Copper + Ag plating from MS8N to MS40N.
- Maximum Temperature : +145°C (293 F)

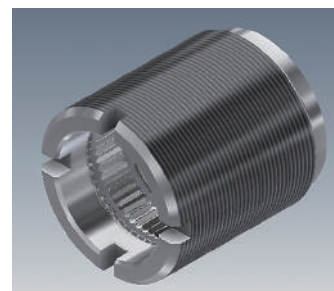
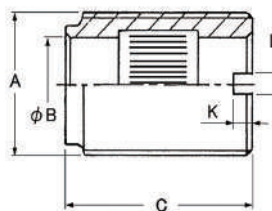

Model	$\phi B$ dia. mm / inches	Rated current (A)	A mm	C mm / inches	K mm / inches	L mm / inches	Contact band	Withdrawal Force (Kg / N)	Insertion Force (Kg / N)	Screw fastening force (max) (Kg.m / N.m)	Contact resistance ( $\mu\Omega$ )	Weight (g / OZ)
MS2N	2 / .08	25	M8x0.75	16.5 / .65	1.5 / .06	1.5 / .06	GCB 5	0.6 / 5.9	0.8 / 7.9	0.3 / 2.94	300	5.1 / 0.18
MS3N	3 / .12	35	M8x0.75	16.5 / .65	1.5 / .06	1.5 / .06	GCB 4	0.8 / 7.9	1 / 9.8	0.3 / 2.94	200	5.2 / 0.18
MS4N	4 / .16	50	M8x0.75	19.5 / .77	1.5 / .06	1.5 / .06	GCB 4	1.5 / 14.7	2.2 / 21.6	0.3 / 2.94	180	6 / 0.21
MS5N	5 / .20	70	M10 x 1	19.5 / .77	2 / .08	1.5 / .06	GCB 3	1.6 / 15.7	2.2 / 21.6	0.5 / 4.9	150	7.2 / 0.25
MS6N	6 / .24	90	M12 x 1	19.5 / .77	2.5 / .10	2 / .08	GCB 3	2 / 19.6	2.5 / 24.5	1 / 9.81	100	11 / 0.39
MS8N	8 / .31	125	M14 x 1	34 / 1.34	2.5 / .10	2.5 / .10	GCB1a	2 / 19.6	2.5 / 24.5	1.3 / 12.75	60	22 / 0.78
MS10N	10 / .39	180	M18 x 1	34 / 1.34	3.5 / .14	3.5 / .14	GCB1a	3 / 29.4	3.5 / 34.3	2.3 / 22.56	50	40 / 1.41
MS12N	12 / .47	230	M20 x 1	34 / 1.34	3.5 / .14	3.5 / .14	GCB1a	3 / 29.4	3.6 / 35.3	3.1 / 30.4	40	44 / 1.55
MS14N	14 / .55	280	M22 x 1	38 / 1.50	4 / .16	4 / .16	GCB1a	4.6 / 45.1	5.1 / 50	3.6 / 35.3	35	58 / 2.05
MS16N	16 / .63	340	M24 x 1	38 / 1.50	4 / .16	4 / .16	GCB1a	6.6 / 64.7	7.1 / 69.6	3.6 / 35.3	25	64 / 2.26
MS18N	18 / .71	400	M28 x 1	42 / 1.65	4 / .16	4 / .16	GCB1a	7.6 / 74.5	10.2 / 100	5.6 / 54.92	20	107 / 3.77
MS20N	20 / .79	460	M30 x 1	42 / 1.65	4 / .16	5 / .16	GCB1a	8.1 / 79.4	12.2 / 119.6	6.6 / 64.72	15	116 / 4.09
MS25N	25 / .98	620	M42 x 1.5	62 / 2.44	5 / .20	5 / .20	GCB1b	8.1 / 79.4	12.2 / 119.6	15.3 / 150	10	402 / 14.18
MS30N	30 / 1.18	1000	M48 x 1.5	62 / 2.44	5 / .20	5 / .20	GCB1b	10.2 / 100	12.2 / 119.6	20.4 / 200	9	496 / 17.50
MS35N	35 / 1.38	1400	M50 x 1.5	62 / 2.44	5 / .20	5 / .20	GCB1b	12.2 / 119.6	15.3 / 150	22.5 / 221	8	436 / 15.38
MS40N	40 / 1.57	1800	M55 x 1.5	62 / 2.44	6 / .24	6 / .24	GCB1b	12.2 / 119.6	15.3 / 150	28.1 / 276	7	482 / 17

# Custom-Made Connectors

## Features and Overview

Globetech offers connectors that are specially designed to meet different conditions, uses, and environments of individual customers. If you face any of the following issues, please consider ordering Globetech custom-made connectors.

### Your Situation

- There is no connector available on the market because the required **current capacity is high**.
- A connector with **highly durable contacts** is needed because of frequent insertion and extraction.
- The connectors currently available do not satisfy the capacity requirements because the sizes do not fit in **the limited space available**.
- Only connectors with **special shapes** can be used.
- A connector made of a material not used in existing connectors is needed for use **in a vacuum**.
- A connector with superior heat resistance is needed for use **in a high temperature environment**.
- Corrosion resistance is required for use in an environment exposed to **corrosive gas**.

In the conditions above, the specifications of existing products are not appropriate. Even if the components can be used, replacement may be required in a short time, or accidents may occur because of abnormal heat and conduction failure. These cases highlight the disadvantages—the costs for the connector and the labor for replacement work reduce production efficiency from the suspension of the device for maintenance and the increase in the risk of accidents.



### Our Suggestions

#### High Current Connectors

- We have many experiences high current connector over 2000A.

#### Longer life Connectors

- We can design highly durable connector.

#### Special Shape Connectors

- We can design according to your specifications.

#### Vacuum Connectors

- We can design according to your permitted materials.

#### Heat Resistance Connectors

- We can design heat resistance connectors up to 680°C(1256°F)

#### Corrosion Proof Connectors

- We can design choosing from many materials and plating.

Our custom-made connectors **reduce operating costs and automate production equipment**. We will contribute to the development of new devices and equipment using our innovative mechanisms. Globetech accepts orders for custom-made items from one unit, and we offer a wide range of components for use in research and development to mass production.

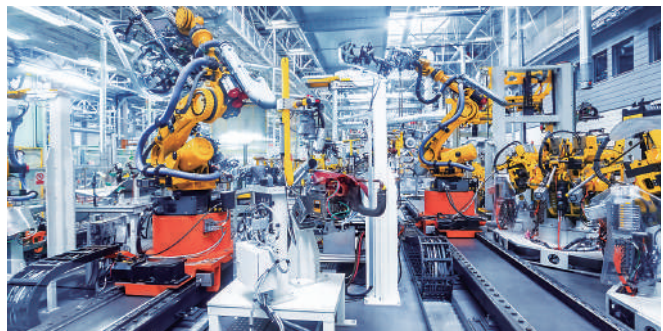



## High Current Connectors

The need for high-current connectors is increasing because of the dissemination of renewable energy, electric vehicles, and other advances in technology. However, heat is easily generated from high currents (generation of Joule heat), which often cause inefficiencies and energization failure.

At Globetech, efficient energization is realized without unnecessary heat generation or energization failure by using electrical contacts.

We design and manufacture custom-made items for use not covered in the standard items shown above. We have supplied many high-current connectors to manufacturers of heavy electric machinery and transmission cables. We can confidently propose products that meet the requirements of individual customers.

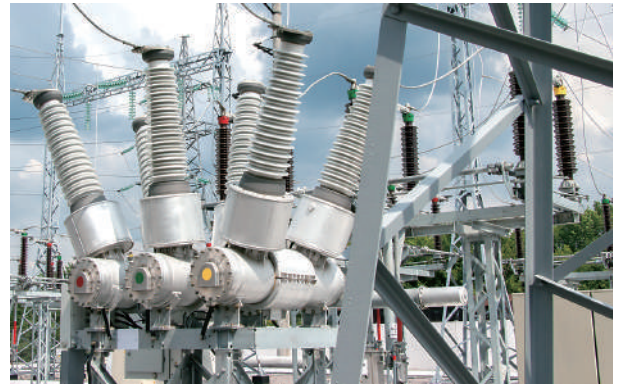

### Features of high our current connector

- Capable of manufacturing high capacity connectors that cannot be handled by existing products. (Theoretically, there is no limitation on the current value.)
- Compact connectors that are usable even under high current conditions.
- A wide range of shapes and specifications are accepted for both single-pole and multi-pole connectors.
- Taking advantage of the flexibility unique to custom-made items, we can design high current connectors in special shapes.

### Example Connection Method

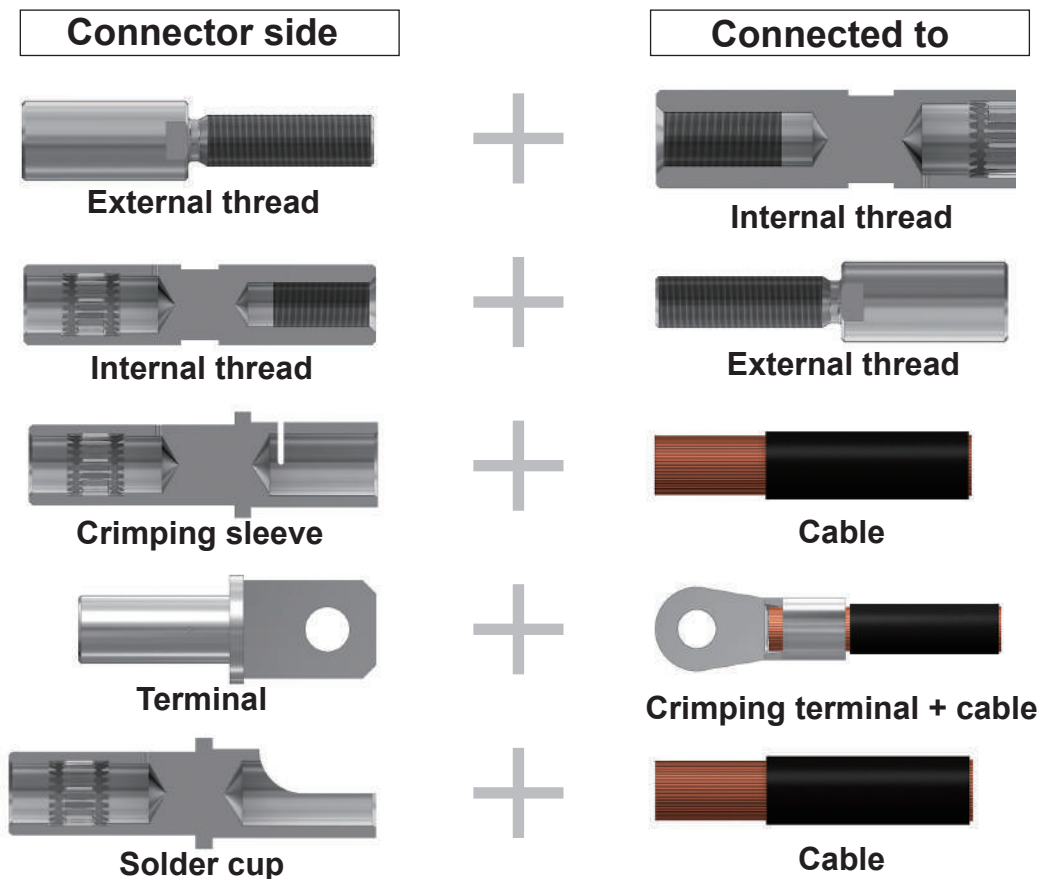

**Samples of high current connector**



Connector for electromagnetic mixer

Current : 1000A  
 Plug diameter :  $\phi 30\text{mm}$  / 1.18in.  
 Electrical contact : Contact band

Silver alloy brazing to angled bar

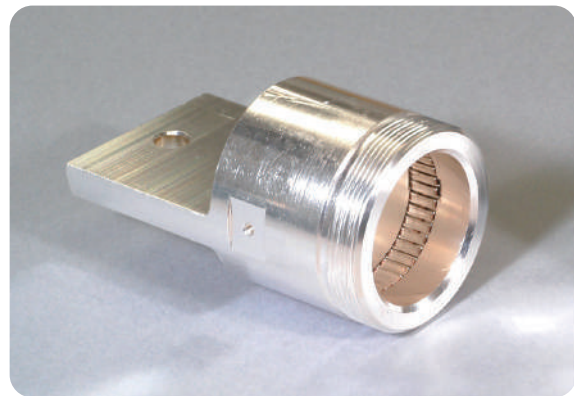

High current Socket

Current : 2000A  
 Plug diameter :  $\phi 50\text{mm}$  / 1.96in.  
 Electrical contact : Contact band

The backside of connector is terminal



Socket for Power distribution equipment

Current : 1000A  
 Plug diameter :  $\phi 30\text{mm}$  / 1.18in.  
 Electrical contact : Contact band

The set screw use for Lock



Cable head

Current : 2000A  
 Plug diameter :  $\phi 60\text{mm}$  / 2.36in.  
 Electrical contact : Contact band

Contact band installed to Plug side.



High current socket

Current : 700A  
 Plug diameter :  $\phi 25\text{mm}$  / .98in.  
 Electrical contact : Coil spring

There are 5 coil springs for touching multi points.



**8P Draw out Connector**

Current : 400A (per pole)  
 Plug diameter :  $\phi$ 14mm / .55in.  
 Electrical contact : Contact band

Automatic attachment and removal



**3P Coaxial connector**

Current : 120A (per pole)  
 Plug diameter :  $\phi$ 8mm / .31in.  
 Electrical contact : Contact band

2 kinds of contact band uses for shield and conductor

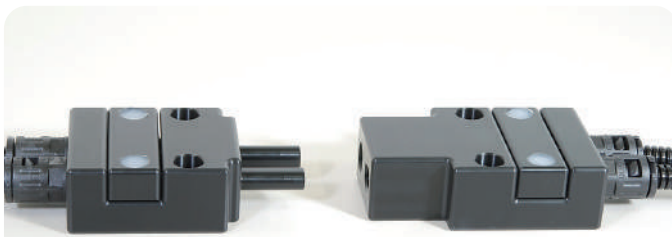

mating

**2P connector for AGV battery connection**

Current : 46A (per pole)  
 Voltage : 125VAC  
 Plug diameter :  $\phi$ 3.6mm / .14in.  
 Electrical contact : Contact band

Wrong insertion prevention structure

**Pulg In Connector**

Current : 700A  
 Voltage : 600VAC  
 Plug diameter :  $\phi$ 20mm / .79in.  
 Electrical contact : Contact band





## Heat Resistant Connectors

Heat-resistant connectors offer superior heat resistance compared to general connectors. The heatproof temperatures of general connectors are about 85°C(185°F) to 125°C(257°F), making it hard to use in high temperature locations, such as near a furnace in an iron mill, or as the cable connection of a heater. Globetech proposes heat-resistant connectors that can withstand up to 680°C(1256°F) by leveraging abundant experience in connector manufacturing.

### Comparison of the material

	General connector	Our Heat Resistant Connector
<b>Electrical Element</b>	Copper alloy (Phosphor bronze / brass)	Nickel alloy / Stainless Steel / Inconel
<b>Insulator</b>	Plastic (PA / PBT / PPS etc)	PTFE / PEEK / Ceramic
<b>Features</b>	-General connector use only up to 125°C(257°F). - Insulator will get damage and contact element reducing spring characteristics.	<b>Inconel can use up to 680°C (1256°F) as electrical contact without reducing spring characteristics.</b>

Caution) Above data is not heatproof temperature of our connectors but materials

### Component parts

#### 1. Electrical Element

We have electrical element with Copper alloy, Nicle alloy, Stainless Steel and Inconel.

Material	Copper alloy	Nicle alloy	Stainless Steel	Inconel
<b>Maximum temperature</b>	180°C / 356°F	220°C / 428°F	370°C / 698°F	680°C / 1256°F

Caution) Above temperature is total temperature of atmosphere temperature + temperature rise of connector.

#### 2. Conductor body

We choose low resistance value change rate metal from Copper, Copper alloy, Stainless Steel and Nickle.

#### 3. Insulator

We choose high and stable insulation performance at high temperature from PTFE, PEEK and ceramic.

#### 4. Casing (Housing)

We calculate coefficient of thermal expansion and choose from Aluminum, Aluminum alloy and Stainless Steel.

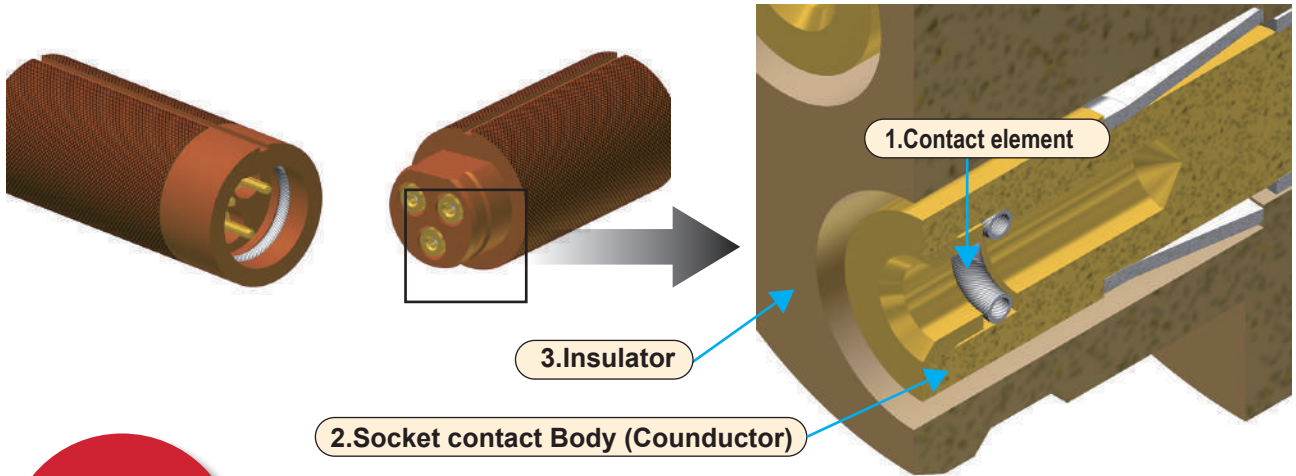

**Samples of Heat Resistant Connectors**

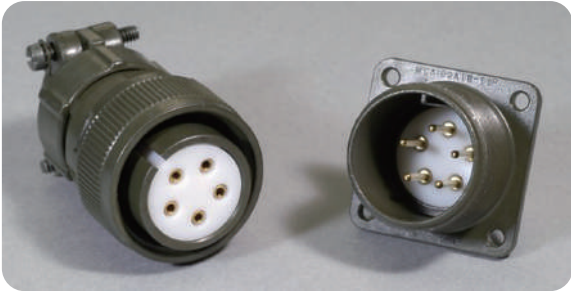

**Bulkhead Connector**

Current : 10A (per pole)  
 Poles : 5 poles  
 Heatproof temperature : 150°C / 302°F  
 Using existing connector casing.  
 We changed Insulator and conductor.



**Inline Connector**

Current : 5A (per pole)  
 Poles : 6 poles  
 Heatproof temperature : 200°C / 392°F  
 Using existing connector casing.  
 We changed Insulator and conductor.  
 Casing is Nicle plating.



**Inline Connector**

Current : 5A (per pole)  
 Poles : 2 poles  
 Heatproof temperature : 500°C / 932°F

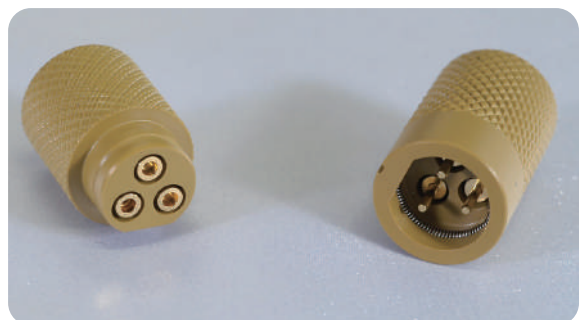

**Inline Connector**

Current : 1A (per pole)  
 Poles : 3 poles  
 Heatproof temperature:350°C / 662°F  
 This Connector has lock.

# Electrical Feedthroughs

The feedthrough and current input terminal are mounted on airtight containers and used to carry electricity (signal or power supply) in and out while retaining airtightness. The feedthrough is usually multipolar and has an allowable current range for signals to the 46A/pin and withstand voltage of up to 1500 VAC. The key feature is that it can be connected using an MIL-standard MS connector to be compact.

The current input terminal is mainly intended for use with high withstand voltage or high current. Different combinations are available for this item. For example, a basic terminal (single pole) can be directly welded to a chamber for use, or multiple terminals are welded to a flange for use as a multipolar current input terminal. Please contact us for products with specifications not covered in the catalogue.

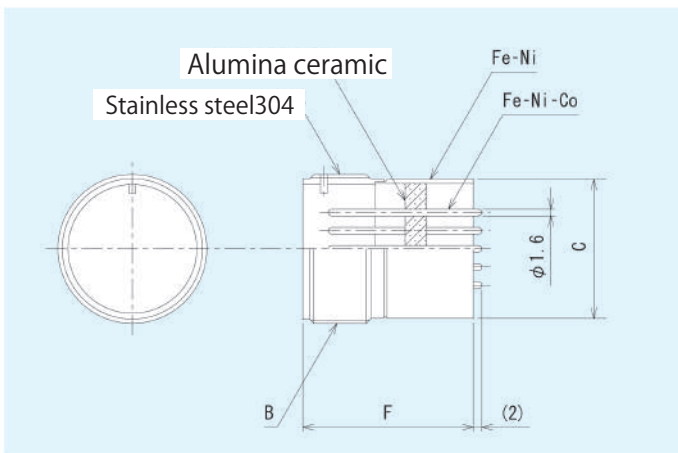

Pin Diameter :  $\phi 1.6 / .06in.$   
 rated Current : 3A (per pin)

Please contact us regarding Flange Type.

Type	Insert arrangement	Poles	B	C	F
Withstand voltage	14S-7	3	7/8-20UNEF	$\phi 20.1$ (.79in.)	35mm (1.38in.)
	14S-2	4			
	14S-6	6			
500VDC (TEST Voltage)	18-1	10	11/8-18UNEF	$\phi 26.1$ (1.03in.)	40mm (1.57in.)
	20-27	14	11/4-18UNEF	$\phi 29.6$ (1.17in.)	
	22-14	19	13/8-18UNEF	$\phi 32.6$ (1.28in.)	
	24-28	24	11/2-18UNEF	$\phi 36.6$ (1.44in.)	
	28-21	37	13/4-18UNS	$\phi 41.1$ (1.62in.)	
	36-10	48	21/4-16UN	$\phi 53.1$ (2.09in.)	
	Withstand voltage 1500VAC (TEST Voltage)	14S-7	3	7/8-20UNEF	
14S-2		4			
18-1		10	11/8-18UNEF	$\phi 26.1$ (1.03in.)	40mm (1.57in.)
20-27		14	11/4-18UNEF	$\phi 29.6$ (1.17in.)	
22-14		19	13/8-18UNEF	$\phi 32.6$ (1.28in.)	
24-28		24	11/2-18UNEF	$\phi 36.6$ (1.44in.)	
28-21		37	13/4-18UNS	$\phi 41.1$ (1.62in.)	
36-10		48	21/4-16UN	$\phi 53.1$ (2.09in.)	



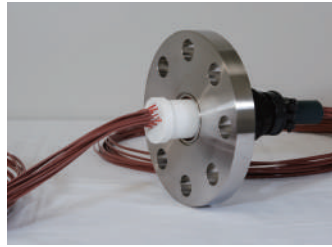
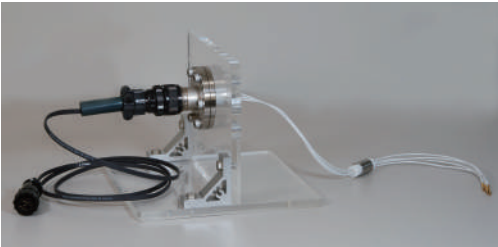
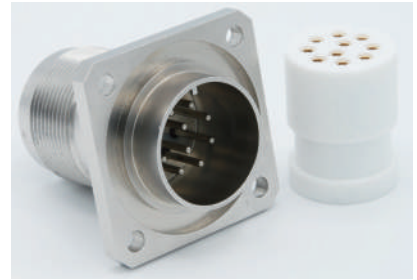
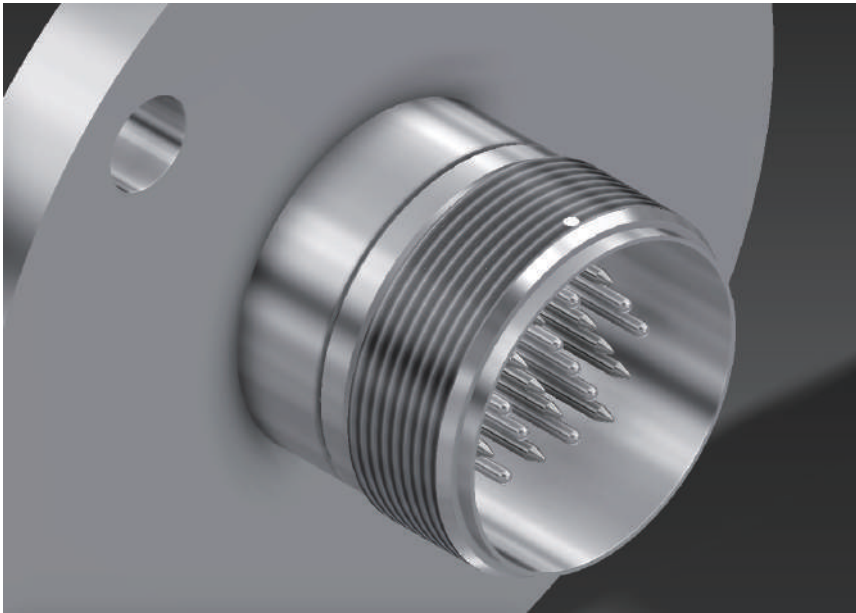

## Electrical Feedthroughs for High Current and High Voltage

Electrical Feedthroughs for Power

Insulation resistance : over 1000MΩ (at 500VDC)

Temperature Range: 200°C (392°F) Baking process 350°C(662°F)

Air tightness : less  $1 \times 10^{-10}$  Pa m<sup>3</sup> /s (Leakage quantity of Helium gas)

		Current							
		~3A	~10A	~15A	~20A	~80A	~100A	~250A	~400A
Withstand Voltage	1kV	○	○	○		○			
	3kV				○		○		
	5kV				○		○	○	○
	12kV				○		○		
	30kV				○		○		

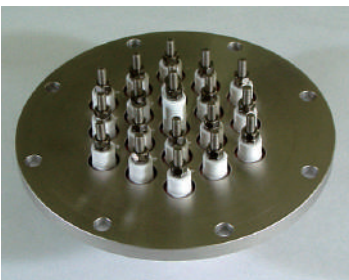

## Vacuum Connectors

Vacuum connectors are mounted on airtight containers (vacuum container, pressure container, container for gas and fluid) and include hermetic connectors, which carry electricity in and out while retaining airtightness and connectors that can bring electricity in containers. Depending on the intended use, we offer a wide variety of items for power supplies, signals, and thermocouples.

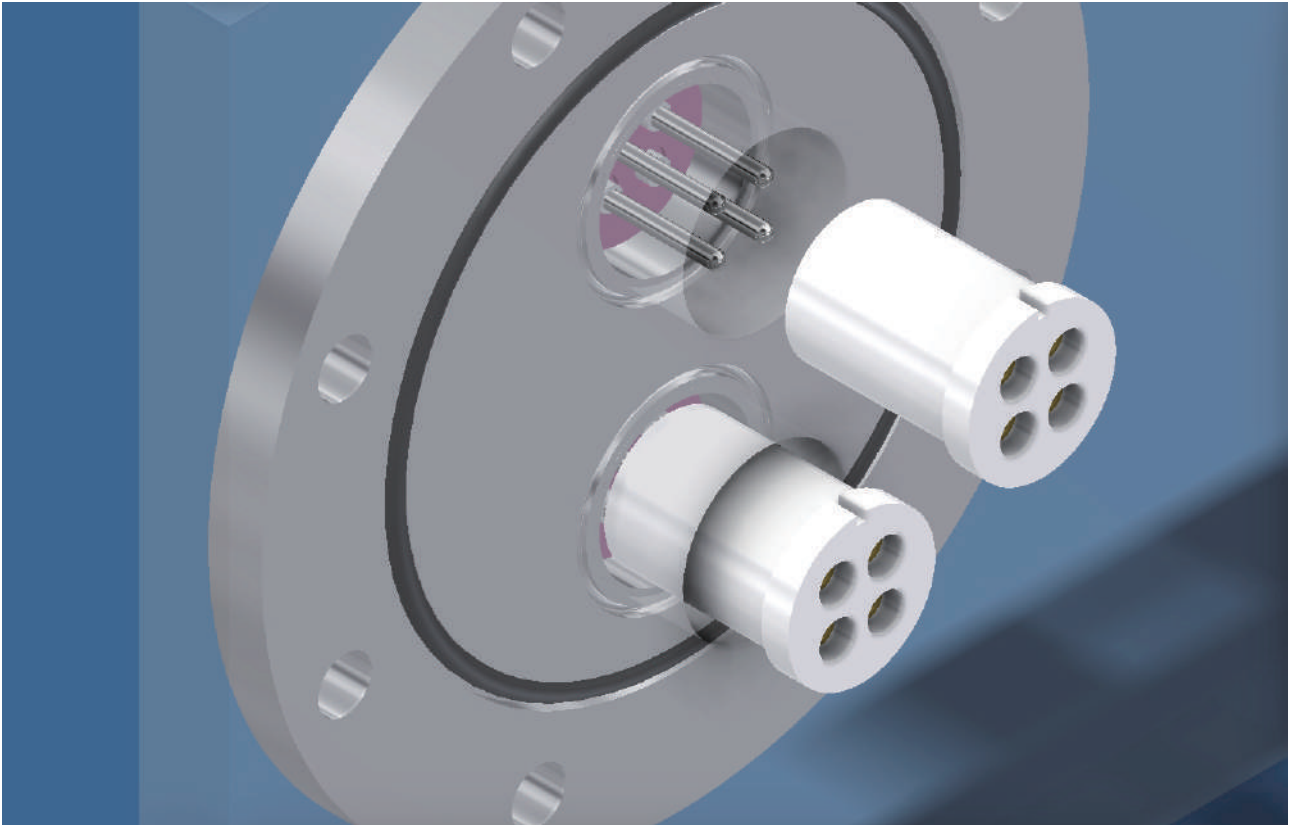

**Socket Contact :** Brass, Oxygen-free copper, Thermocouple Type K, T and E  
**Insulator :** PTFE, PEEK and Ceramic



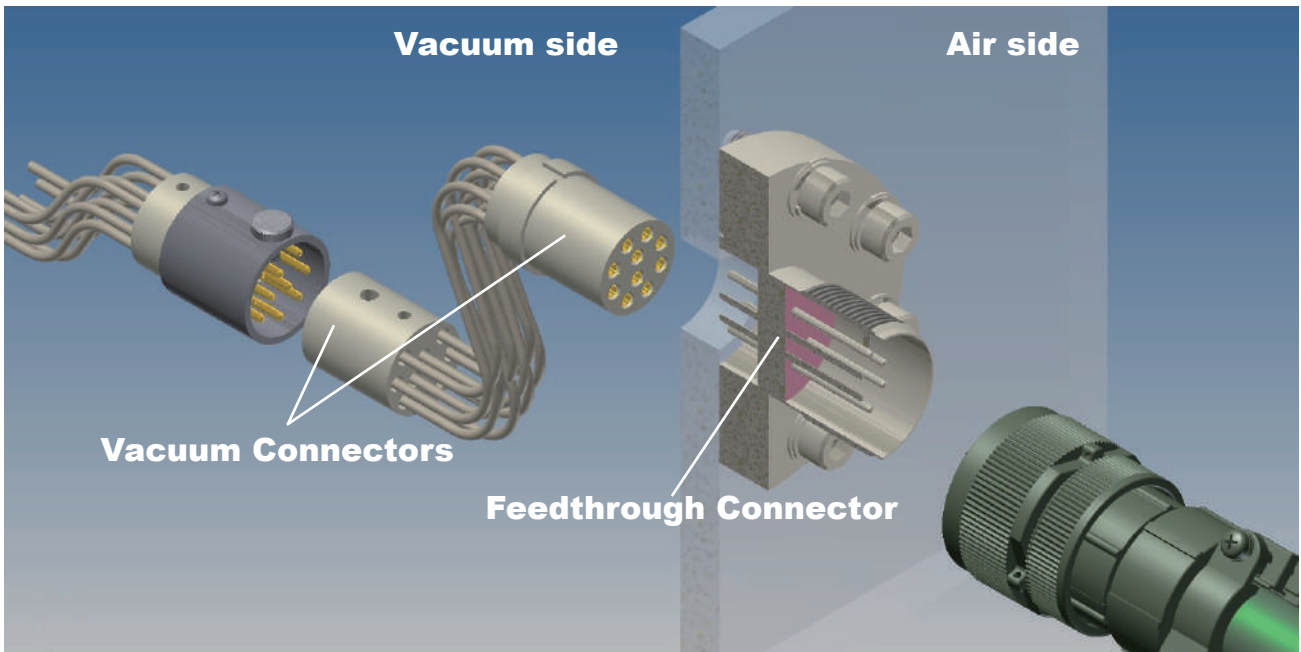

**Samples of vacuum connectors**

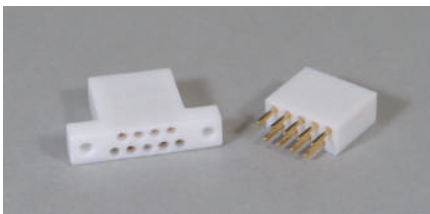
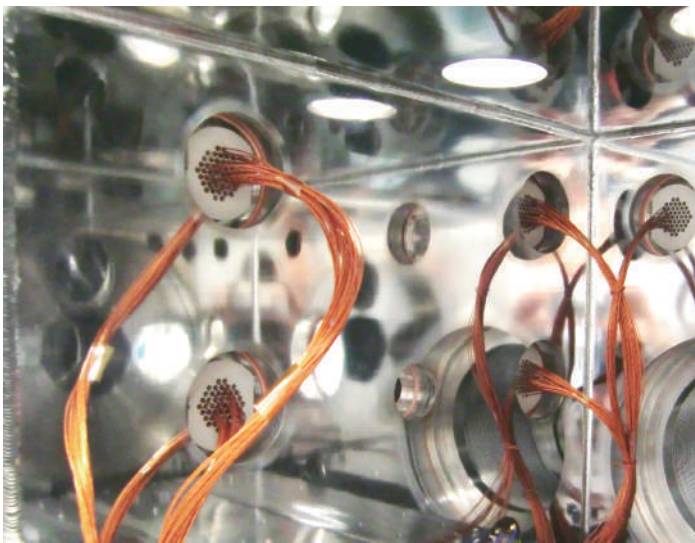



## **FORK SOCKET**

The fork socket is a connector used when the mating component has a flat plate shape. The socket has an opening designed to match the plate thickness of the mating component and the flat electrical contacts on the inner surface. The socket is suitable for connections between a bus bar on the rear part of the unit used in rack and panel products and the power supply on the case, connections between cells in a battery (flat terminal), and bus duct connections, which results in a wide range of applications from mounting on high-current products to simplified pre-shipment inspections.

### **Features**

- Structure suitable for use with high current
- Compensates for misalignment in one direction
- Design flexibility for super-thin to thick plate thickness
- Connections are very simple

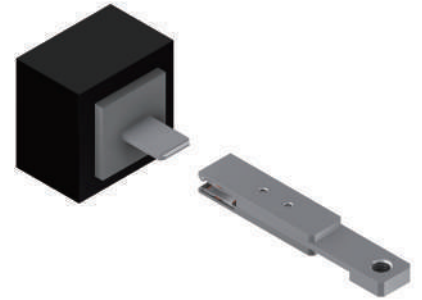

### **FORK SOCKET**

Bus bar thickness/width : 5mm(.20in.) / 25mm(.98in.)

Current : 500A

Contact element : GCB8

Conductive body is copper +Ag plating

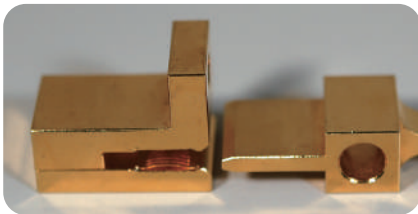

Before mating

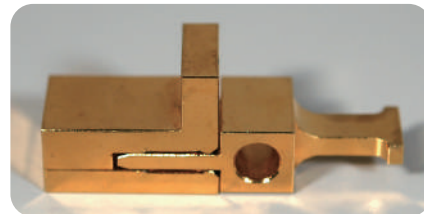

After mating

### **FORK SOCKET**

Bus bar thickness/width 2.5mm(.10 in.) / 14mm(.55in.)

Current : 100A

Contact element:GCB4

Corrosion proof

Conductive body and contact element are Au plating



**Samples  
of  
Fork Socket**

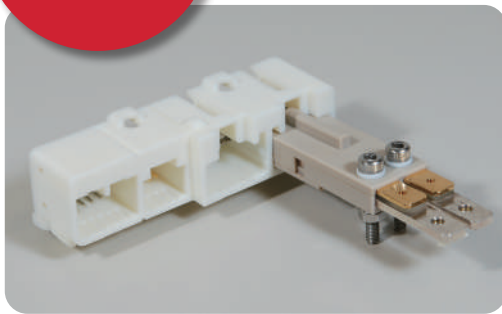

***Fork socket for Substrate inspection***

Bus bar thickness/width : 2mm(.08in.) / 6.4mm(.25in.)  
 Current : 25A  
 Contact element : GCB8 and GCB5

This fork socket is inspection for Automotive board.



***Fork socket for AGV***

Bus bar thickness/width 5mm(.20in.) / 50mm(1.97in.)  
 Current : 60A  
 Contact element:GCB8

Large taper and prevent Misalignment

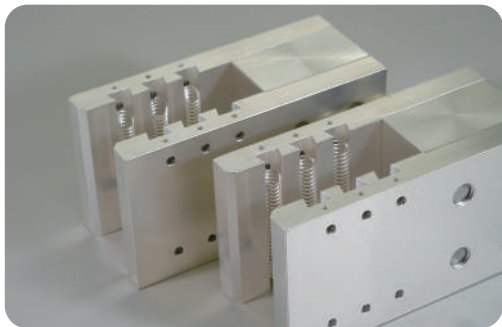

***Fork socket for High current***

Bus bar thickness/width 20mm(.79in.) / 100mm(3.94in.)  
 Current : 1500A  
 Contact element:Coil Spring

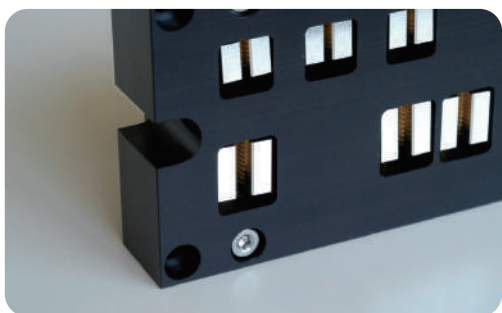

***Multi fork sockets with insulator***

Bus bar thickness/width 4mm(.16in.) / 15mm(.59in.)  
 Current : 100A  
 Contact element:GCB8

Easy mating to multi bus bars

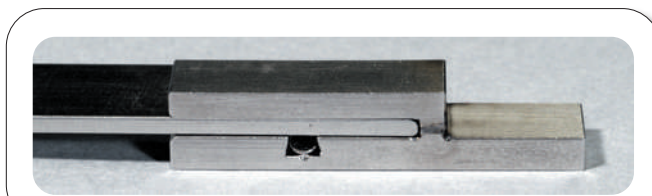
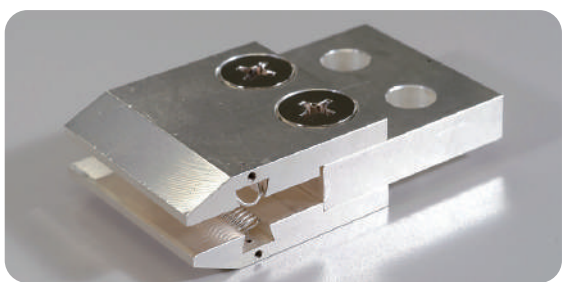

## Draw Out Connector (For Automatic Equipment)

The draw out connector is mounted between devices or panels. Unlike other types of connectors inserted and extracted by hand, this one fits together on a rail or is automatically inserted and extracted by the movement of a cylinder. This is also called a rack and panel connector or an automatic connector.

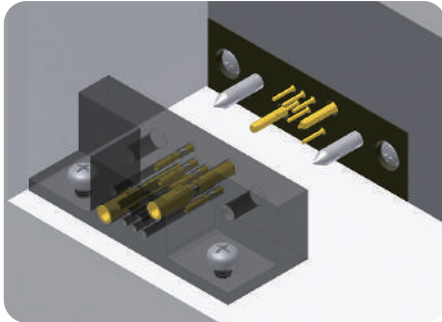
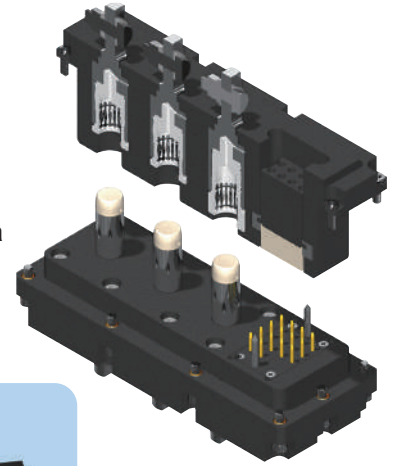

Rack and panel

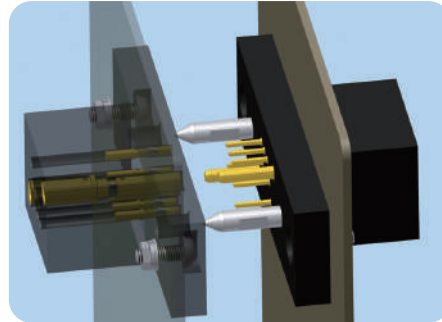

Panel to Panel

Some representative issues with these applications are that the plug and receptacle are inserted even when misaligned in the event of any looseness in the rail or tolerance deviation when the cylinder is mounted. This can be a serious problem because a long service life is needed since the connector is frequently inserted and extracted.

### Examples

Mating using shape of the case

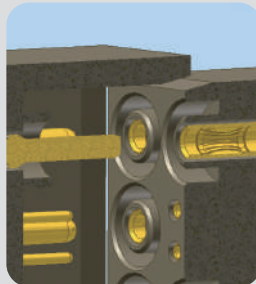

Mating using the guide pin and tapered hole

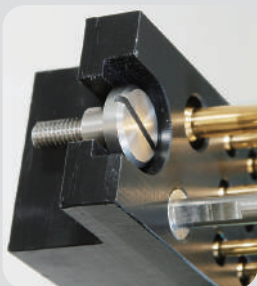

Fixation using a floating screw

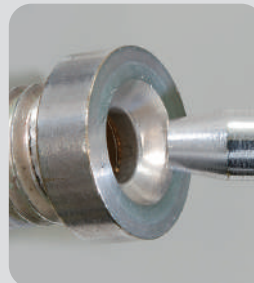

Mating using the pin tip and tapered shape of the socket inlet

For mating a pin and socket, care must be taken of the contact strength. Either the plug or receptacle must have a floating mechanism on a fixed point with the device or panel so that the connector tracks guide movement. For wiring of the connector side with the floating mechanism, a wiring method that does not obstruct guide movement, such as a cable or flexible conductor, is required. Rigid fixation to the bus bar disables guide movement. In such a case, only deflection of the electrical contact works to compensate for any misalignment.

**Samples  
of  
Draw Out  
connector**



**Draw Out with both Power and Signals**

Poles : 2P(Power) and 6P(Signal)  
Misalignment allowance :  $\pm 1\text{mm}$  /  $\pm .039\text{in.}$

We can customise poles under your specification



**Draw Out for High Temperature**

Poles : 3P  
Current : 20A  
Temperature :  $250^{\circ}\text{C}$  (482F)

We can design for higher temperature product

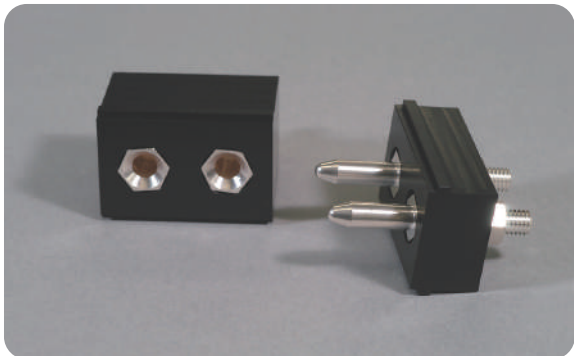

**Draw Out for High Current**

Poles : 2P  
Current : 80A

We can design for higher current product



**Draw Out for Coaxial / Thermocouple**

Poles : 6P(Coaxial) / 8P(Signal)  
Current : 20A

Mixing normal signals and thermocouple type K

# BUTT CONTACT

While connectors are generally inserted, Globetech offers connectors that make contact by pressing the surfaces (butt contact) based on the technology of electrical contacts. Using butt contacts for pre-shipment inspections makes the work simpler (shortened time) and automated.

	Contact spring probe	<b>BUTT CONTACT</b>
If the contact surface is rough ...	Contact defects may occur depending on the surface roughness.	Each of the coil springs individually tracks the irregular surface to maintain stable energization.
Canted contact	Because there is only one contact, energization issues may arise.	Multipoint contact and deflection of the coil spring ensure stable energization.
Damage	The product may be damaged because of the force applied to a single contact.	Damage to the product can be minimized because the force is distributed to multiple contact

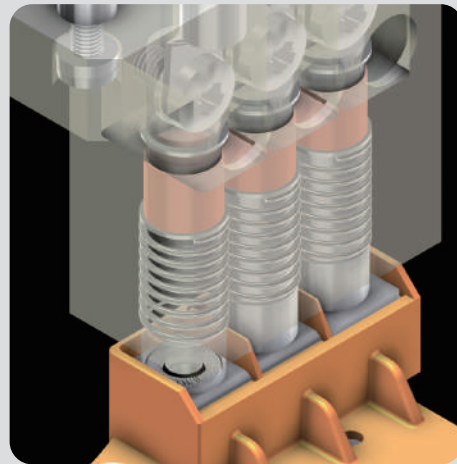
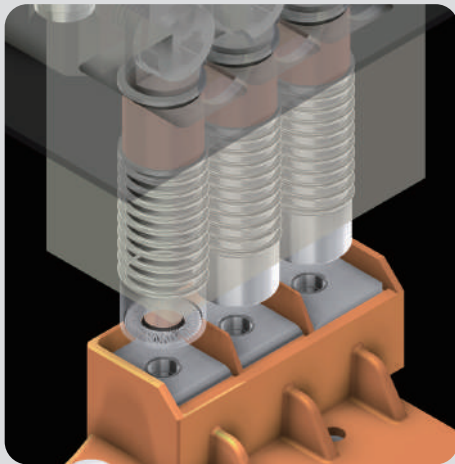

Contacted

## Features

- Small but energizes high current
- Unlikely to damage the target compared to a contact spring probe that has only one contact because the target is touched at multiple points
- The coil spring flexibly tracks the irregular surface of the target.
- Compensating for misalignment by increasing the target surface
- Applicable to high temperature environments or vacuums by changing materials
- Longer life compared to connectors using a pin and socket



## Inspection contact for IGBT and Terminal

While a crimped terminal is connected using a screw in actual use, in a pre-shipment inspection, it is necessary to inspect as many products as possible within a limited time. By using a butt contact, time and labor for screwing the crimped terminal is eliminated, and the manufacturing and shipment lines are automated, which leads to cost reductions.

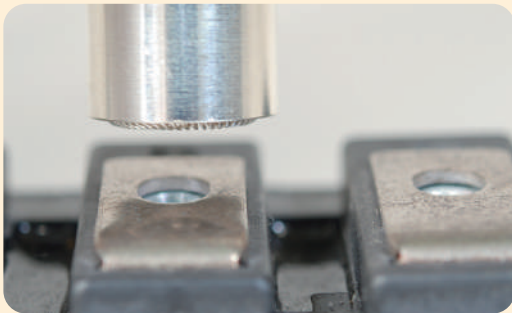
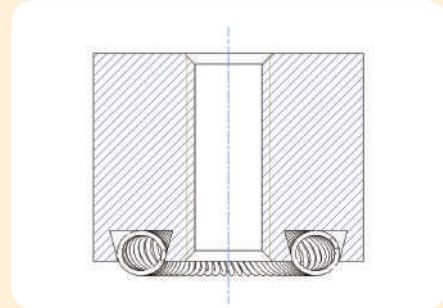

The butt contact is used in the current and breakdown tests of the pre-shipment inspection of the IGBT. Stable energization is ensured by multipoint contact, and damage to the terminal block of the IGBT can be minimized. Large deflection, which is one of the key features of a coil spring, compensates for any misalignment in the direction of height when more than one terminal is energized at the same time.

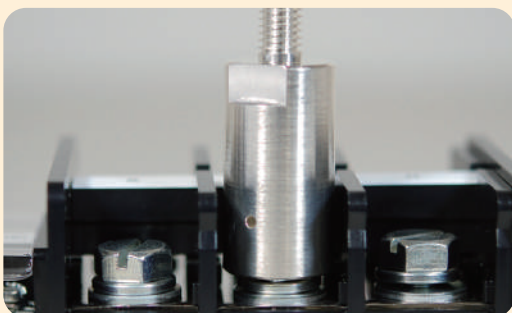
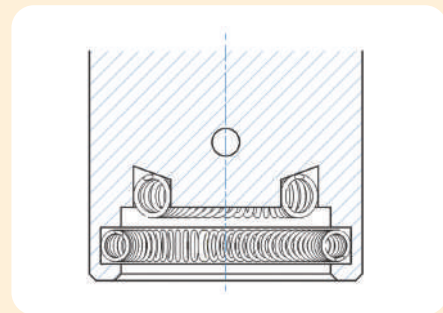

The butt contact is used in the current test of a general-use terminal board. Even more stable energization is ensured by energizing the two directions of the upper and lateral sides using two coil springs for the screw head. Designing and manufacturing custom-made products are accepted in accordance with the size of the screw head of the terminal board.

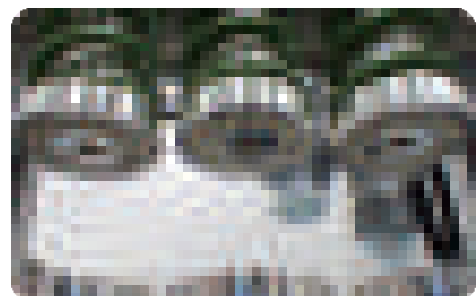
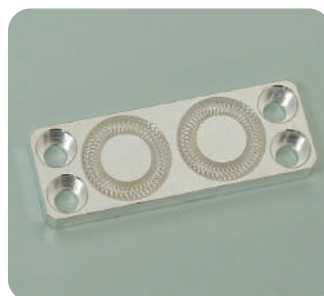
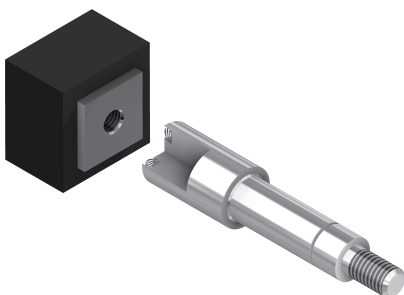

## High Current Probes

### BC Series

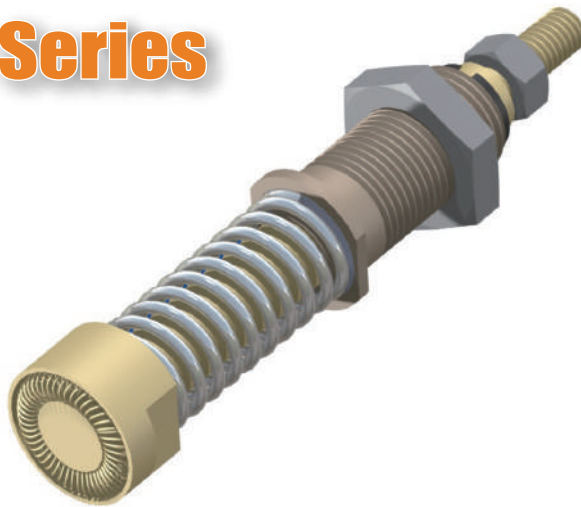

- Stable energizing
- Reduces scratches to the products
- Running cost down

#### Advantages of the Butt Contact

**-It reduces defective products by using a stable energizing contact.**

High contact reliability is achieved by ensuring that the coil spring is in contact with the touching surface therefore a stable contact is achieved.

**-It reduces scratches to the products**

The canted coil spring makes a soft contact with the inspection target with multiple points of contact.

**-It keeps running costs down**

It has passed 1 million cycles in our in-house endurance test. Since it is highly durable, it reduces the frequency of maintenance and it last longer than other existing probes.

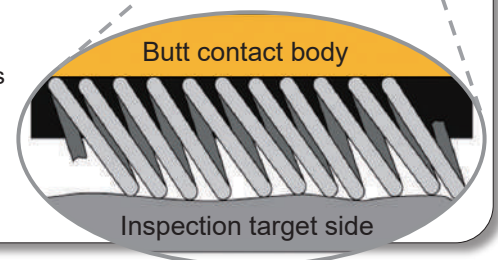
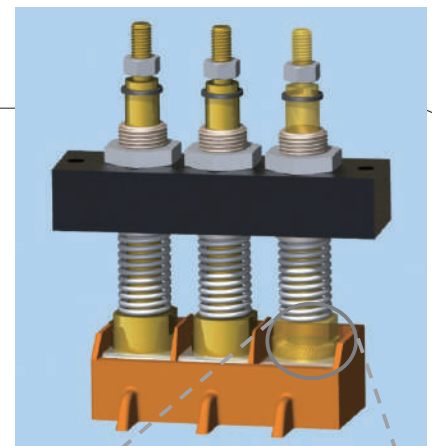

Each coil spring contact follows the roughness of the target surface.

#### Application examples

- For shipment inspection of power semiconductor modules and smart meters.
- For manufacturing inspection process for automobile parts.
- Used for power supply connection for Auto Guided Vehicles (AGV).
- For operation check in the production process of inverters, etc.
- Lithium-ion battery charging.

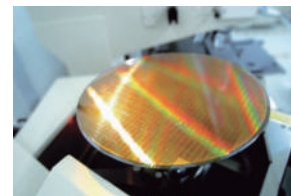

■ Product line-up

There are 4 types of Butt Contact.

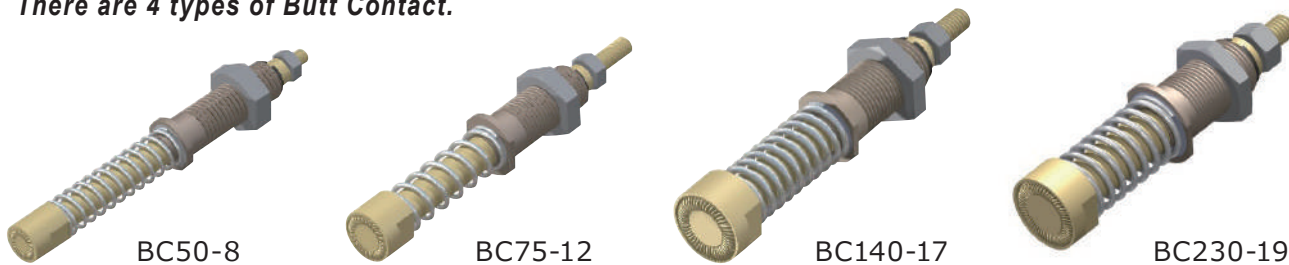

Model	Rated current	Tip diameter	Pressurizing spring force	Screw size
BC50-8	50A	φ8 mm	5N~9N	M3
BC75-12	75A	φ12 mm	16N ~ 28N	M4
BC140-17	140A	φ16.5 mm	16N ~ 28N	M5
BC230-19	230A	φ18.5 mm	16N ~ 29N	M6

■ How to mount

Procedure 1

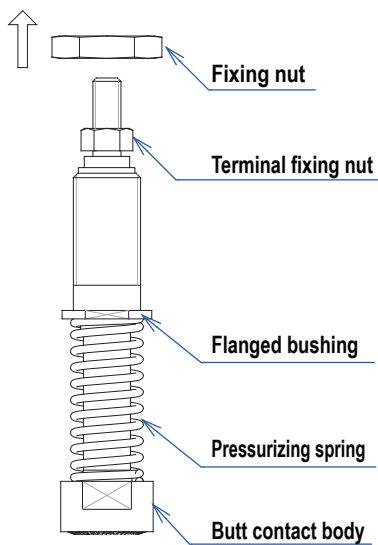

1. Remove the fixing nut from the flanged bushing.

Procedure 2

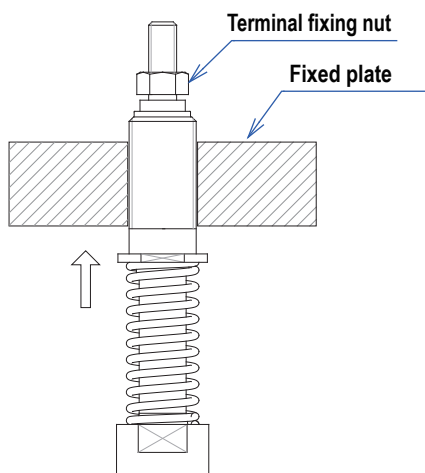

2. Insert the Butt Contact into the hole to be fixed.

Procedure 3

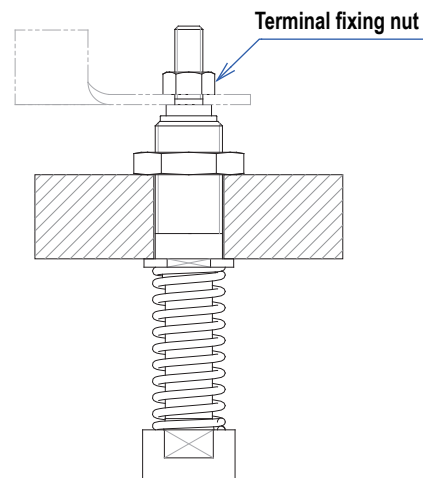

3. Tighten the nut to fix the Butt Contact. Tighten it by crimping the terminal with a nut.

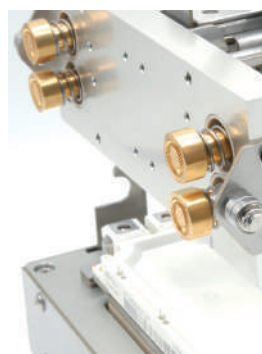
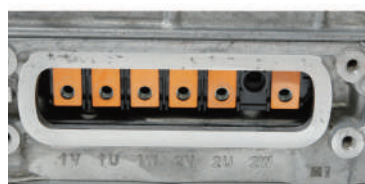



## Connecters for Inspection Process

GlobeTech proposes a custom-made connectors for your product inspection process. The inspection process time and cost can be greatly reduced.

### Inverter inspection for Automotive

**Butt Contact**  
High Current and stable contact



**For 0.64mm square pin**  
**0.64mm Socket**  
Long life





**Fork Socket**  
Four terminal sensing method



**Zero Insertion Force Connector**  
Reducing scratch

Slide pipe



Without Contact Force



With Contact Force

### Inspection process for Battery



#### Four terminal sensing method

Four terminal sensing is an electrical impedance measuring technique that uses separate pairs of current-carrying and voltage-sensing electrodes to make more accurate measurements.



## Connect to Hex Nuts and Screw threads

Globetech's connectors use electrical contacts that can be directly connected to the lateral surfaces of hex nuts or screw threads. Thus, energization does not require a round terminal or special jigs. This is the best method when the work efficiency of pre-shipment inspections or other work is considered important. Moreover, as electrical contact tracks even sections where tolerance of the mounting hole is large, secure electrical connections are ensured.

We can design connectors based on your specifications.

### Example

#### Connect to Hex Nuts and Screws

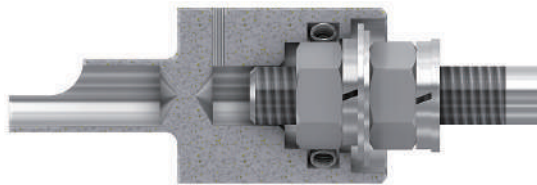
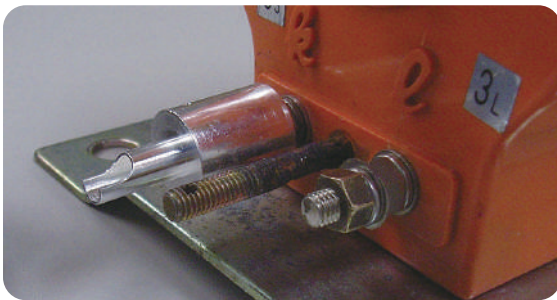

M8 Nuts 5A 24V

#### Connect to internal thread and external thread

Conducting to internal thread

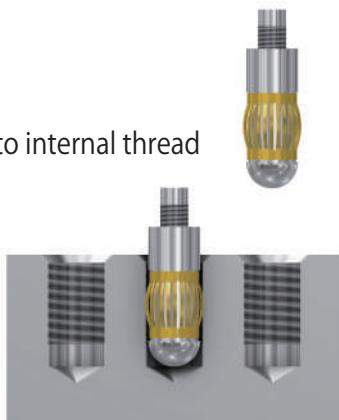

Conducting to external thread



#### One connector to 2 different hole size

Connect to 2 different hole size at same time



Connect to each 2 different hole size

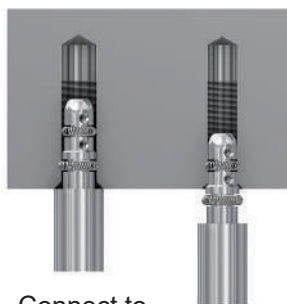

## Other samples

### Square flange with 48 poles sockets

Current : 200A/32P, 40A/16P  
 Voltage : 40VAC / 100VAC  
 Plug Diameter :  $\phi$ 12 and 5mm / .47 and .20in.  
 Electrical contact : Contact band

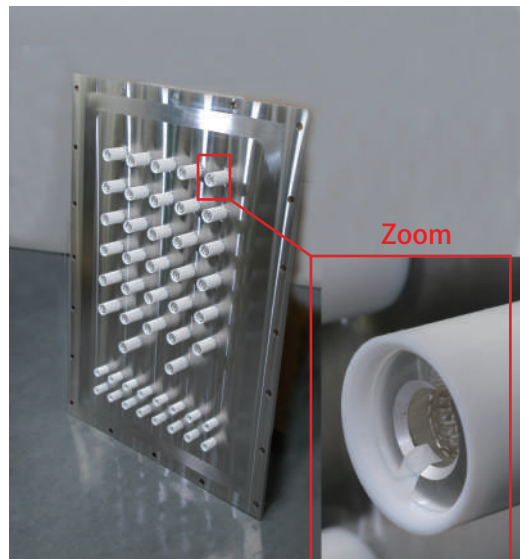

### EV BUS Battery

Current : 300A x 3 poles  
 Plug diameter :  $\phi$ 16mm / .63in.  
 Electrical contact : Contact band

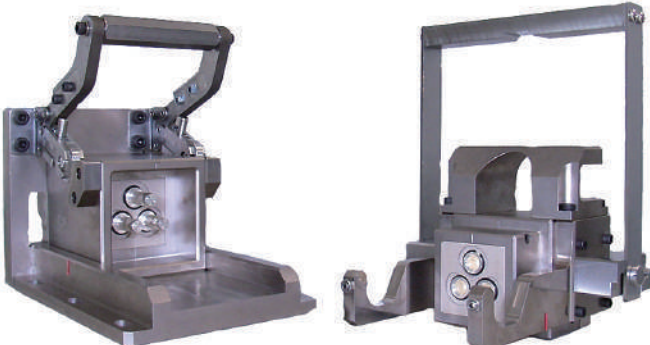
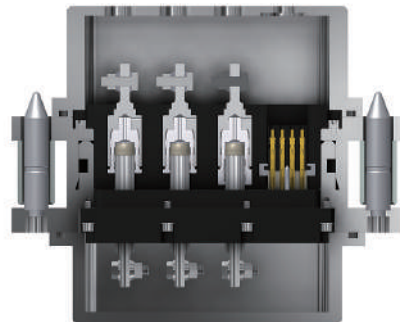

### Connector for Manipulator

Current : 230A (singular pole)  
 Voltage : 400VAC  
 Plug diameter :  $\phi$ 12mm / .47in.  
 Electrical contact: Contact band

We use PEEK for insulator for Radiation-proof.



**Connector with Latch lock  
(Cable assembly)**

Current : 230A (singular pole)  
 Plug diameter :  $\phi$ 12mm / .47in.  
 Electrical contact : Contact band

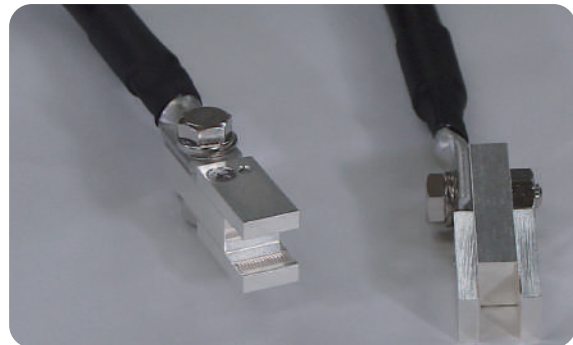

**Fork Socket  
(Cable assembly)**

Current : 100A  
 Bus bar thickness : 5mm / .20in.  
 Electrical contact : Contact band

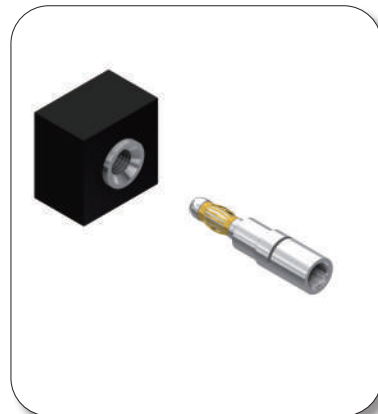
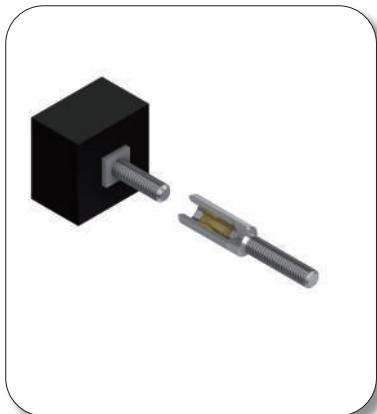

**Crimp tool**

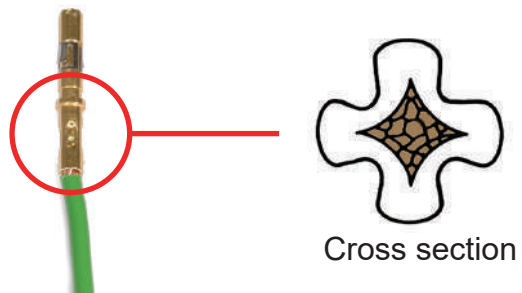

Cross section

**4-Indent Hand Crimp Tool**

This tool crimp from four directions, which ensures secure pressure bonding and does not cause the bonded portion to spread or bend.

**Removal tool**



Specifications are subject to change without notice.



1-13-21 Hinodai  
Hino-shi, Tokyo, Japan 191-0003  
<http://www.globetech.jp/>